

ATEX LED WORKLITE

WL-85, WL-80

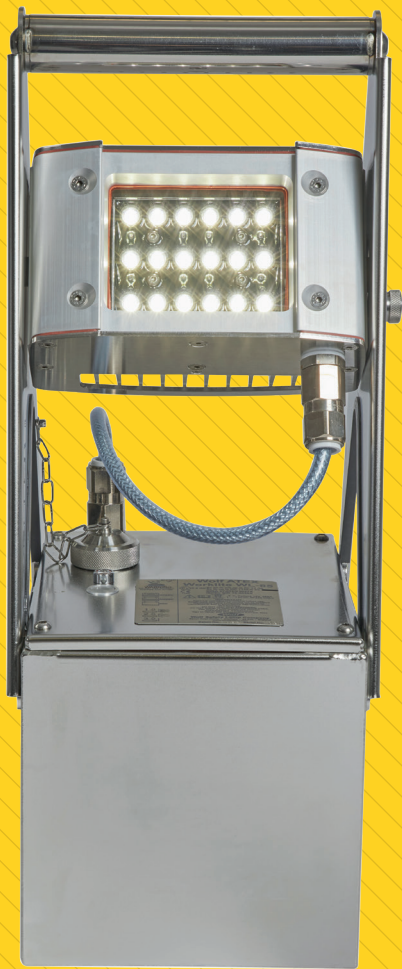

OPERATION AND MAINTENANCE INSTRUCTIONS



CONTENTS

EU Declaration of Conformity	3
UK Declaration of Conformity	3
Approval Codes/Certification	3
IECEX Scheme Certification	4
Special Conditions of Use (X Condition)	4
Photobiological Safety	4
Disposable Lenses	4
Worklite Models	4
Use of the Wolf Worklite	5
Operation	5
Head Angle Adjustment	5
Battery Level Indication	5
Charging	5
Charger Status LEDs	5
Maintenance	6
Removal of battery enclosure lid	6
Re-fitting lid	6
Disconnecting the Battery	6
Removal of lamp head	7
Battery Replacement WL-80	7
Battery Replacement WL-85	8
Switch Replacement	8
Charge Socket Assembly Replacement	9
Indicator Replacement	9
Glass Lens Replacement	9
LED Panel Replacement	9
Control Circuit Replacement	10
Cable Replacement	11
Spare Parts List	11
Replacement Battery	11

Wolf ATEX Rechargeable Worklite Range

Operation and Maintenance Instructions

Please Retain – Read Before Use

EU Declaration of Conformity

The Wolf ATEX Worklite WL-80 and WL-85 meets all relevant provisions of the 2014/34/EU Explosive Atmospheres (ATEX Equipment) Directive by virtue of the issued EU type examination certificate, and subsequent review confirming compliance with all relevant harmonised standards and essential health and safety requirements.

The Wolf ATEX Worklite is a self-contained portable Worklight with a durable construction of stainless steel and anodised aluminium enclosures. The Worklite is powered by a sealed lead acid battery available in two sizes and supplying arrays of 18 High Power LEDs. The Worklite range is approved as Group II, Category 2 equipment for use in zone 1 & 2 potentially explosive atmospheres containing gases, vapours, mists, and dusts where the T4 temperature class/135°C maximum surface temperature permits.

Approval Codes/Certification:

 II 2 GD Ex eb ib mb IIC T4 Gb
Ex tb IIIC T135°C Db
Tamb = -20°C to +40°C

EU Type examination certificate: **CML18ATEX3373X**

Notified Body: SGS Fimko OY. P.O. Box 30 (Särkiniementie 3),
00211 HELSINKI. Finland

Notified body number: **0598**

Harmonised standards applied: EN IEC 60079-0:2018, EN IEC 60079-7:2015+A1:2018,
EN60079-11:2012, EN60079-18:2015+A1:2017, IEC 60079-31:2022.

Ingress protection level: **IP66, IP67** to EN60529:1992,

Wolf Worklites are certified compliant with the 2014/30/EU EMC Directive to the following harmonised EMC standards BS EN 61000-6-3:2007+A1:2011 and BS EN 61000-6-2:2005

The **WL-150 Worklite Chargers** are certified compliant with the 2014/30/EU EMC Directive and 2014/35/EU Low Voltage Directive to the following harmonised EMC standards; EN 55032:2012 Class B, IEC 61000-3-2:2014, IEC 61000-3-3:2013, EN 55024:2010 and to the following LVD standards; EN 62368-1:2020.

The Wolf ATEX Worklite WL-80, WL-85 and WL-150 charger is also Compliant with the 2011/65/EU RoHS Directive to the harmonised standard EN IEC 63000:2018

This declaration is issued under the sole responsibility of Wolf Safety Lamp Company.



Alex Jackson – Managing Director
Wolf Safety Lamp Company Ltd., Sheffield, S8 0YA
Dated: 01 April 2024

UK Declaration of Conformity

The Wolf ATEX Worklites WL-80 and WL-85 meets all the statutory requirements of the Equipment and Protective Systems Intended for Use in Potentially Explosive Atmospheres Regulations 2016, UKSI 2016/1107 as amended by UKSI 2019/696 by virtue of the issued UKEX type examination certificate, demonstrating compliance with all relevant designated standards and essential health and safety requirements.

Approval Code:



II 2GD Ex eb ib mb IIC T4 Gb
Ex tb IIIC T135°C Db.
Tamb = -20°C to +40°C

UK Type examination certificate: **CML 21UKEX3646X**

Approved Body: SGS Baseefa Ltd, Rockhead Business Park, Staden Lane, Buxton, SK17 9RZ, UK.

Approval body number: **1180**

Designated Standards Applied: EN IEC 60079-0:2018, EN IEC 60079-7:2015+A1:2018, EN 60079-11:2012, EN IEC 60079-18:2015+A1:2017, IEC 60079-31:2022

Wolf Worklites also meet all the statutory requirements of the UK EMC Regulations 2016, UKSI 2016/1091 as amended by UKSI 2019/696 to the following relevant designated standards:- BS EN 61000-6-2:2005, EN 61000-6-3:2007+A1:2011

The **Wolf Charger WL-150 for WL-80 and WL-85** meet all the statutory requirements of the UK EMC Regulations 2016, UKSI 2016/1091 as amended by UKSI 2019/696 to the following relevant designated standards:- EN 55032:2012 Class B, IEC 61000-3-2: 2014 IEC 61000-3-3: 2013, EN 55024:2010 and the following designated electrical safety standard EN 62368-1:2014 +A11:2017

The Wolf ATEX Worklite WL-80, WL-85 and WL-150 charger is also compliant with the Restriction of the Use of Certain Hazardous Substances in Electrical and Electronic Equipment Regulations 2012, UKSI 2012/3032 to the designated standard EN IEC 63000:2018.

This declaration is issued under the sole responsibility of Wolf Safety Lamp Company.

Alex Jackson – Managing Director
Wolf Safety Lamp Company Ltd., Sheffield, S8 0YA
Dated: 01 April 2024

IECEx Scheme Certification

Certificate Number: **IECEx CML18.0199X**

Ex eb ib mb IIC T4 Gb
Ex tb IIIC T135°C Db
Tamb = -20°C to +40°C

IEC Standards applied: IEC60079-0:2017, IEC60079-7:2017, IEC60079-11:2011, IEC60079-18:2014, IEC60079-31:2022

Special Conditions of Use (X Condition)

The Worklite can be fitted with an optional lens cover, this should be checked, and replaced when the light output is obscured by damage or contaminant.

Photobiological Safety: EN62471:2008

Risk Group 2

CAUTION: Possibly hazardous optical Radiation emitted from this product.
Do not stare at operating lamp. May be harmful to the eye.

Inspect the following before each use:

- If any damage is visible to any seals or the glass lens, replace if necessary.
- Charge socket cover is in place and tightened by hand
- Cable should have no tears/splits or signs of separation from glands
- The unit is clean and dust has not built up on any surfaces

Any damaged or missing Worklite parts should be replaced or repaired in accordance with these instructions, before being put back into service.

Repair work may ONLY be carried out by qualified technicians using components supplied by Wolf and fitted in accordance with these instructions.

Caution when handling:

Precautions should be taken when lifting and carrying heavy objects.

Following extended use, The lamp head can get hot. Do not cover head fins.

Disposable Lenses:

Anti-static lens covers W-200 (Pk.3) can be fitted to protect the Worklite glass lens from damage.

See **Special conditions of Use (X Condition)**

Worklite Models:

The following information throughout this document refers to Worklite models manufactured after year 2018. A post 2018 model can be identified by: i)LED Panel-This will have 18 LED's surrounded by black encapsulant ii) Date code on approval label, on the lid the approval label will be stamped with a date in the form YY (year) and week number WW; anything with date code 1800 or over. iii) An IECEx Certificate number IECEx SIR 18.0028X will be on the approval label

Contact Wolf Safety for previous issues of instructions to cover models prior to 2018.

TABLE 1:

Model	Battery	Lamp	High Pwr Duration	Low Pwr Duration	Charge Duration
WL-85	12V 35 Ah	18 LED 3100lm	~21h	~40h	~12h
WL-80	12V 18 Ah	18 LED 3100lm	~15h	~22h	~8h

Use of the Wolf Worklite

First Use: Please Read

Remove protective switch cap and charge fully before first use.

- Operation:**
- Press Switch Once – ON Full Power
 - Press Switch Again – ON Half Power
 - Press Switch Again – OFF



Head Angle Adjustment: To adjust head angle for your work area, retract the indexing plunger and angle lamp head.

Battery Level Indication:

The indicator LED on the enclosure lid will indicate in the sequence as shown in table 2. Actual indication periods may vary as a result of temperature, charge cycle, battery condition, and electrical tolerances. When the battery level is very low; the red indicator and beam will flash - charge the battery as soon as possible to maintain good battery life.

To assess whether a battery needs to be replaced, the duration of a full discharge should be compared with table 1. If <70%, replace the battery.

TABLE 2 (@High Power Duration)

		
WL-85	~3 hours	~14 hours 4 hours
WL-80	~3 hours	~10 hours 2 hours

Deep discharge protection: The lamp will automatically cut off when the battery reaches a pre-determined low voltage. A red followed by flashing red indicator and flashing beam will warn of imminent cut-off. The lamp must be re-charged as soon as possible before further use or storage.

Storage: Due to the self-discharge characteristics of this type of Lead Acid battery, it is imperative that it is charged every SIX months when in storage, otherwise permanent loss of capacity might occur.

Cleaning: Use a mild soap and water and soft brush only. Do not immerse.

Charging:

Use only the **WL-150 Worklite Charger**.

The charge socket cover must first be removed before the charger plug can be connected.

The Worklite indicator will show flashing Red and Green when connected to a charger.

Charger Status LEDs

RED = Mains power connected and charger is switched ON.

ORANGE = Charging (Cooling fan on fast speed).

GREEN = Fully Charged (Cooling fan on slow speed).

The charger continues to supply a trickle charge and can be left in this mode on standby.

WL-150 has a system to detect when the battery in the Worklite has reached the end of its life and cannot be charged. At the end of the normal charging period if the RED LED is OFF and the other LED is ORANGE or GREEN (and no LED indication on the worklite) then the battery in the Worklite **must** be replaced.

To ensure the ingress protection level is maintained, The charge socket cover **MUST** be re-fitted to the charge socket and tightened beforehand. (Ensure area around charge socket is free from dirt)

- Do not charge in Hazardous Area.
- Charger operating ambient: +10°C to +25°C.
- Charger ingress protection IP20, protect from dirt and moisture.
- Do not cover ventilation slots.
- When charger is not in use: disconnect from Worklite.

The **WL-150 Charger** is rated to the following.

Peak Output Current (during charge period) = 4.0A

Peak Output Voltage (at battery, during bulk charge) = 14.6V max

Voltage on Trickle Charge = 13.8V

Maintenance. [Repair by qualified technicians ONLY]

Disconnect battery before maintenance to any of the Worklite circuit.

USE Caution when handling batteries.

Do not allow cables or battery terminals to short across any metal parts.

Removal of battery enclosure lid.

Remove the four retaining screws W-405 and lift and slide the enclosure lid rearward taking care not to pull on any of the connecting wires inside the enclosure.

Before carrying out any work on cable, lamp, switch or indicator connections, it is important to disconnect the battery first.

Re-fitting lid, Ensure the vent pipe is properly fitted to connections and is tucked inside the enclosure. Ensure the lid is fitted in the correct orientation and that seal W-300 is in place. Ensure that no wires overhang this seal, the box edge or the battery top foam or rest directly above the battery terminals when tightening each of the four lid retaining screws W-405. Tighten screws in equal increments to ensure lid lowers evenly (Seal W-300 is bonded to the enclosure).

Disconnecting the Battery, with the enclosure lid not obscuring the battery, pull back the terminal covers and disconnect the battery.

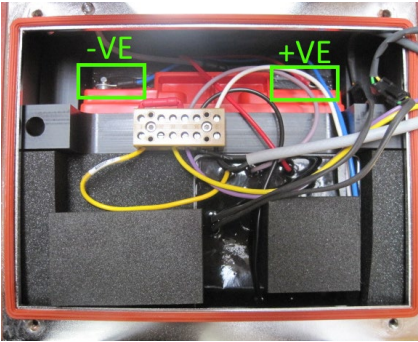

WL-80 Battery

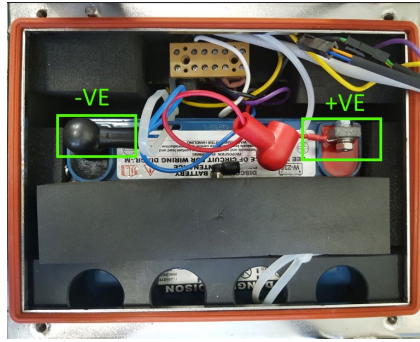

WL-85 Battery

Fig 1

Disconnect each battery lead in turn and make sure the lead is made electrically safe and cannot inadvertently reconnect to the battery terminal.

Torque Setting: Battery Enclosure Lid Screws (x4) = 3.0Nm

Removal of lamp head.

i) Loosen handle bolts W-433, ii) Loosen pivot bolts W-411 and whilst supporting the head, remove pivot bolts, retract the indexer and spread the side plates by approx 5mm lifting the head upwards and backward until it is free and it can then be rested upside down next to the box. (Avoid pulling on the cable) When re-fitting lamp head, ensure threaded hole in lamp head aligns centrally with spacer washers and hole in frame prior to fully tightening pivot bolts.

Torque Setting: Handle (x2) = 10.0 Nm

Torque Setting: Pivot Bolts (x2) = 6.0 Nm (Use Loctite 222 on thread)

Battery Replacement WL-80

To replace **W-218** 18Ah battery in **WL-80**:

Unscrew the two terminal block retaining screws (A) to remove terminal block and remove cross-piece retaining screws at (B). The circuit block (C), foam block (D) and foam side piece (E) can now be removed in that order. Disconnect vent pipe at (F) by pressing on the blue ring of the fitting while pulling on the pipe. The Worklite box can now be tipped on to its side so the battery stands upright and the top of the battery can be pulled forward and removed from the box. Disconnect battery wires and replace battery. Re-fitting is the reverse of the above. Ensure vent pipe is connected to fitting under flange.

A short charge with charger WL-150 will be required each time a battery is re-connected before the lamp will light.

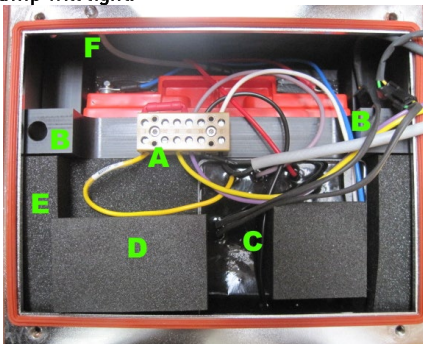

Fig 2

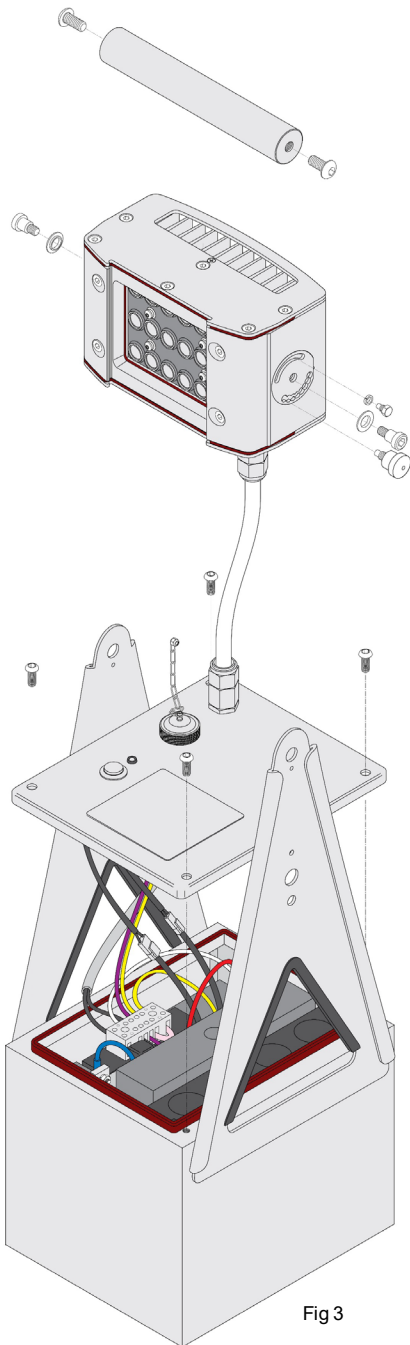

Fig 3

Battery Replacement: WL-85

(Requires removal of both lamp head and enclosure lid)

To replace: **W-235 35Ah** battery in a **WL-85**

First disconnect both wires from the battery. Disconnect the vent pipe from the fitting under the flange by pressing on the white ring to release the pipe. Remove circuit top foam from under box flange and disconnect vent pipe from under flange. Lift the encapsulated circuit block assembly from alongside the battery, remove from the box and place next to the lid again taking care not to snag any cables.

To replace battery, remove foam and spacers which surround the circuit, slide battery forward to release top spacer and lift battery out taking care not to short the battery terminals on enclosure flange or metal tools.

Re-assembly is the reverse of above, See fig 4 for foam/spacer positions and orientations. Inspect all wire connections, connect battery terminals. Refit terminal covers. Re-connect vent pipe.

A short charge duration will be required each time a battery is re-connected before the lamp will light.

Component Replacement Procedures – Applies to all Models:

Switch Replacement:

(Requires removal of enclosure lid – see above)

i) Disconnect the switch connector. ii) Using a spanner, remove switch locknut and push switch through lid. iii) Place new switch in lid ensuring o-seal is in place, fit and tighten. iv) re-connect the 3-way connector, re-fit any removed packing foam and replace lid as per enclosure lid removal instructions above.

Torque Setting: Switch Locknut = 2.5Nm

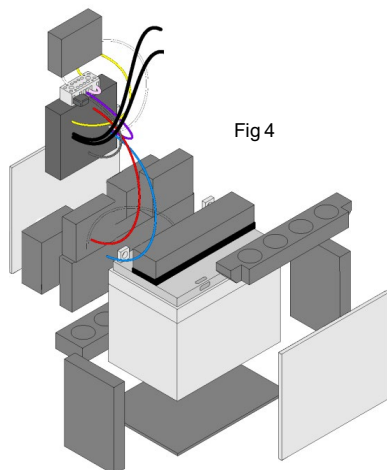

Fig 4

Charge Socket Assembly Replacement:

(Requires removal of enclosure lid – see above)

i) Lift circuit block assembly from enclosure to gain access to terminal block. ii) Disconnect charger socket wires (Yellow and Violet) from the terminal block, iii) Unscrew Charge Cap and move to one side. iv) Remove the three screws retaining the charge socket base from the underside of the lid. v) The old base can now be lifted out and replacement fitted in the reverse order of the above ensuring that the o-rings are in place and in good condition. vi) Connect the Yellow and Violet charge socket wires in to the terminal block as shown on the terminal block label.

Torque Setting: Charge Socket retaining Screws = 2.0Nm

Indicator Replacement:

(Requires removal of enclosure lid – see above)

i) Disconnect the indicator LED connector. ii) Using a spanner, remove locknut and pull the indicator housing through the lid, iii) grip the lower part of the LED holder and unscrew the housing from the assembly, iv) the LED can now be released through the underside of the lid, Assembly is the reversal of removal, take care not to twist or stress the cable while screwing the lower part of the indicator to the housing and ensure o-seals are in place, v) connect 2 way connector and assemble as above.

Torque Setting: Indicator Locknut = 2.8Nm

Glass Lens Replacement.

i) Loosen and remove the six screws (W-414) retaining the lamp TOP plate, ii) Partially loosen off the four lens clamp screws (W-421) until the lens is free to move, iii) Carefully slide the old lens upwards and out, and replace with new lens and seal, [Ensure seal fits squarely around the new lens after insertion]. iv) Gradually tighten each of the four W-421 lens screws, v) re-fit top plate ensuring that the seal edge follows the edge of the plate and that the holes align and that no dirt particles are present on the sealing edge. Tighten all six screws.

Torque Setting: Top/Bottom Plate retaining Screws (x12) = 3.2Nm

Torque Setting: Lens Clamp Screws (x4) = 3.2Nm

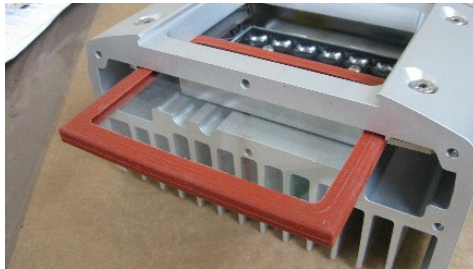

Fig: 5

LED Panel Replacement:

(Requires removal of the head and disconnection of battery)

i) Follow "Glass Lens Replacement" steps i to iii above to remove the lens, ii) Loosen and remove the screws (W-404) retaining the LED board. Remove the two right-hand lens screws completely and now remove the six W-414 screws retaining the lamp bottom plate, iii) The LED board, lower plate, clamping plate and connector block can now all be separated from the head. [Take care not to damage the LED lenses when handling], iv) the LED panel can now be disconnected from the connector block and the new LED board connected Red to No.1, Black to No.2 See Fig 6

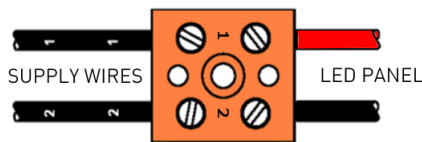

Fig 6

v) feed the LED board up in to the head and ensure that the thermal pad is in position with holes aligned. Insert and tighten screws W-404 and line up the lens clamp threaded holes with the screws, Partially tighten, See Fig: 7. Fit bottom plate and tighten the six screws, vi) Re-assemble as per iii, iv and v from Glass Lens Replacement.

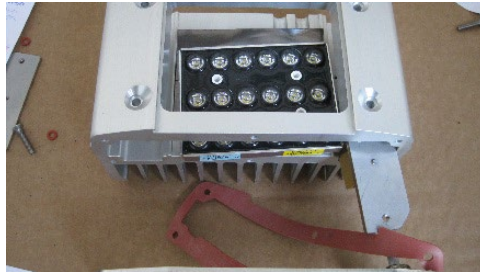

Fig: 7

Note: A THERMAL PAD MUST ALWAYS BE USED

Torque Setting: LED PCB Screws (x4) = 2.5Nm

Control Circuit Replacement:

(Requires removal of enclosure lid)

i) Disconnect the Battery. ii) At the terminal block; disconnect Lamp Output wires identified as '1' and '2' (or 'blue/brown) and Yellow and Violet (charge socket) and also the two connectors to the switch and the indicator LED. The circuit block can now be removed and the new Circuit fitted, see Fig: 8 for connections. **Always connect the battery last.**

Torque Setting: Terminal Block Screws = 0.5Nm

Model	Description	Battery Pt No:	Circuit Spare Pt No:
WL-85	12V 35 Ah 18 LED	W-235	W-4941
WL-80	12V 18 Ah 18 LED	W-218	W-5341

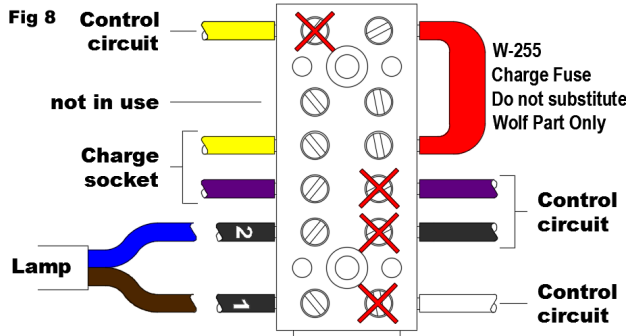

X DO NOT REMOVE FROM TERMINAL BLOCK

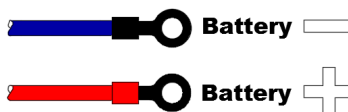

Cable Replacement

(Requires removal of the lamp head and disconnection of battery)

i) Follow steps i to iii from 'LED Board Replacement', ii) Disconnect terminal block from cable assembly and using a spanner, remove the cable gland locknut and remove the cable gland from the bottom plate. iii) Disconnect the cable from the terminal block, tilt the battery enclosure top-plate to expose the cable gland locknut, If necessary, disconnect the switch and indicator, lift the circuit block from the enclosure if necessary. iv) Remove the locknut, and completely remove the cable assembly from the Worklite, v) Fitting is the reverse of the above, fit the cable gland in to enclosure lid and lamp head bottom plate ensuring that the gland seal is external and the shakeproof washer and locknuts are internal. vi) Connect the new cable to the head connector block; No.1 to Red, No.2 to Black, see fig 5 and re install the LED board, lens clamp plate and bottom plate as per the instructions above. vii) In the battery enclosure; connect the wires in to the connector block No.1 (brown) to White, No.2 (blue) to Black viii) Re-connect any disconnected switch or indicator cables and replace the circuit block if necessary. When all wire connections are checked and the head has been re-assembled, the battery can now be connected and the enclosure lid replaced [ensuring no cables are snagged, or obstructing the sealing edge when the lid is in position].

Torque Setting: Cable Gland Locknut = 18Nm

For re-assembly; ensure all foam blocks are correctly inserted as per fig 2 /fig 4, and re-fit lid.

Spare Parts List:

Part No.	Description	Used on:
W-200	3 x Antistatic Lens Guards in Bag	WL-85 & WL-80
W-201	Cable and Gland Assembly	WL-85 & WL-80
W-202	Battery Foam Kit 18Ah Battery	WL-80
W-255	Charge Fuse: HBC	WL-85 & WL-80
W-204	Battery Foam Kit 35Ah Battery	WL-85
W-205	Index Plunger Kit	WL-85 & WL-80
W-206	Head Pivot Bolts and Washer Kit	WL-85 & WL-80
W-207	Charge Socket Cap and Chain	WL-85 & WL-80
W-208	4 x Enclosure Lid Screws (W-415)	WL-85 & WL-80
W-209	Lens Glass, Lens Seal & O-ring kit	WL-85 & WL-80
W-210	Head Seal and set of Screws	WL-85 & WL-80
W-213	Charge Socket with Base, Seals & Screws	WL-85 & WL-80
W-300	Battery Enclosure Lid Seal	WL-85 & WL-80
W-244	Switch Assembly with wires/connector.	WL-85 & WL-80
W-180	18 LED Panel, Thermal Pad and Screws	WL-85 & WL-80
W-246	Lid Indicator LED Assembly	WL-85 & WL-80
W-524	Charge Socket 'O' ring seal.	WL-85 & WL-80

Replacement Battery:

WL-85 12V 35Ah pt.no. W-235 ONLY
WL-80 12V 18Ah pt.no. W-218 ONLY

A short charge with charger WL-150 will be required each time a battery is re-connected before the lamp will light.

WARNING:

- USE ONLY WOLF CHARGERS WITH THESE PRODUCTS
- USE ONLY GENUINE WOLF REPLACEMENT PARTS.
- LAMP MUST NOT BE USED WITHOUT BATTERY SPACERS AND PACKING CORRECTLY IN POSITION
- LAMP MUST NOT BE USED WITHOUT CHARGE CAP FITTED

DISPOSAL OF WASTE MATERIAL

Disposal of packaging, redundant WL-80 or WL-85 products and parts should be carried out in accordance with applicable regulations.



Wolf ATEX Rechargeable Worklite Features

- Ideal for Task lighting and work activities in a hazardous area
- ATEX, UKEX and IECEx approved for Zone 1 and 21 explosive gas and dust atmospheres.
- High power 'fitted for life' LED light source
- High quality, even, ultra-wide angle LED light, reduces shadows and enhances visibility
- Medium angle flood beam
- Up to 40 Hours Battery Life



WOLF SAFETY LAMP COMPANY

Saxon Road Works,
Sheffield S8 0YA, UK

T: +44 114 255 1051

E: info@wolfsafety.com

W: www.wolfsafety.com



ATEX

